

**SIRUBA®**

銀箭牌工業用縫紉機

INDUSTRIAL SEWING MACHINE

**L818F-RM1**

WITH TRIMMER

零件圖 PARTS LIST



CE



高林股份有限公司  
KAULIN MFG. CO., LTD.

MODEL 機 型	SUB-CLASS 規 格	OPERATING PANEL 操作盒	GAUGE WIDTH 切邊距離	NEEDLE PLATE 針 板	FEED DOG 送 具	PRESSER FOOT 押 具	HOOK ASM 梭 頭	BOBBIN CASE ASM 梭 殼	BOBBIN 梭 子	THROAT PLATE CHIP GUARD 下導布架	NEEDLE 針 號	THREAD GUIDE 導線片	THROAT PLATE COVER 布板蓋	HAND WHEEL 皮帶輪
L818F-RM1-32-00 L818F-RM1-32-03	32	LA55F-A	1/8" (3.2mm)	E705Q (E705S)	D705 (D702)	P705 (P701)	G121	G202	G303	LR104DS (LR104D)	DB*1#14	LR141S (LR141)	LR106S (LR106)	GLH101-A1
L818F-RM1-32-10 L818F-RM1-32-13		HL600												
L818F-RM1-40-00 L818F-RM1-40-03	40	LA55F-A	5/32" (4.0mm)	E705R (E705Q)	D705	P705	G121	G202	G303	LR104DS	DB*1#14	LR141S	LR106	GLH101-A1
L818F-RM1-40-10 L818F-RM1-40-13		HL600												

## 規格件表 CONVERSION CHART

# 規格件表 CONVERSION CHART

MODEL 機 型	SUB-CLASS 規 格	OPERATING PANEL 操作盒	GAUGE WIDTH 切邊距離	NEEDLE PLATE 針 板	FEED DOG 送 具	PRESSER FOOT 押 具	HOOK ASM 梭 頭	BOBBIN CASE ASM 梭 殼	BOBBIN 梭 子	THROAT PLATE CHIP GUARD 下導布架	NEEDLE 針 號	THREAD GUIDE 導線片	THROAT PLATE COVER 布板蓋	HAND WHEEL 皮帶轉輪
L818F-RM1-48-00 L818F-RM1-48-03	48	LA55F-A	3/16" (4.8mm)	E705 (E705Q)	D705	P705	G121	G202	G303	LR104DS	DB*4#14	LR141S	LR106	GLH101-A1
L818F-RM1-48-10 L818F-RM1-48-13		HL600												
L818F-RM1-64-00 L818F-RM1-64-03	64	LA55F-A	1/4" (6.4mm)	E705S (E705Q)	D702 (D705)	P701 (P705)	G121	G202	G303	LR104D (LR104DS)	DB*4#14	LR141 (LR141S)	LR106S (LR106)	GLH101-A1
L818F-RM1-64-10 L818F-RM1-64-13		HL600												

MODEL	SUB-CLASS	OPERATING PANEL	GAUGE WIDTH	NEEDLE PLATE	FEED DOG	PRESSER FOOT	HOOK ASM	BOBBIN CASE ASM	BOBBIN	THROAT PLATE CHIP GUARD	NEEDLE	THREAD GUIDE	THROAT PLATE COVER	HAND WHEEL
機 型	規 格	操作盒	切邊距離	針 板	送 具	押 具	梭 頭	梭 殼	梭 子	下導布架	針 號	導線片	布板蓋	皮帶輪
L818F-RM1-95-00	95	LA55F-A	3/8" (9.5mm)	E705T (E705Q)	D702 (D705)	P701 (P705)	G121	G202	G303	LR104D (LR104DS)	DB*1#14	LR141 (LR141S)	LR106T (LR106)	GLH101-A1
L818F-RM1-95-03														
L818F-RM1-95-10														
L818F-RM1-95-13														



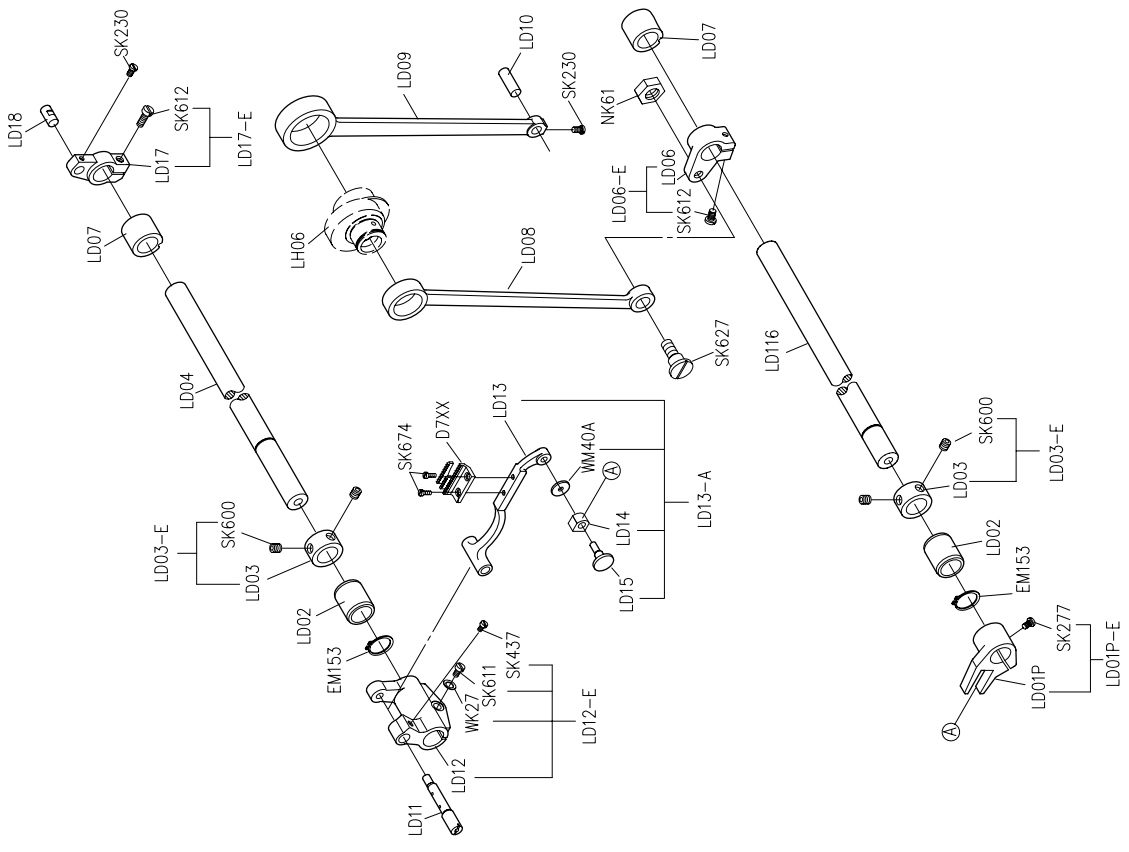

PARTS LIST FOR LD GROUP

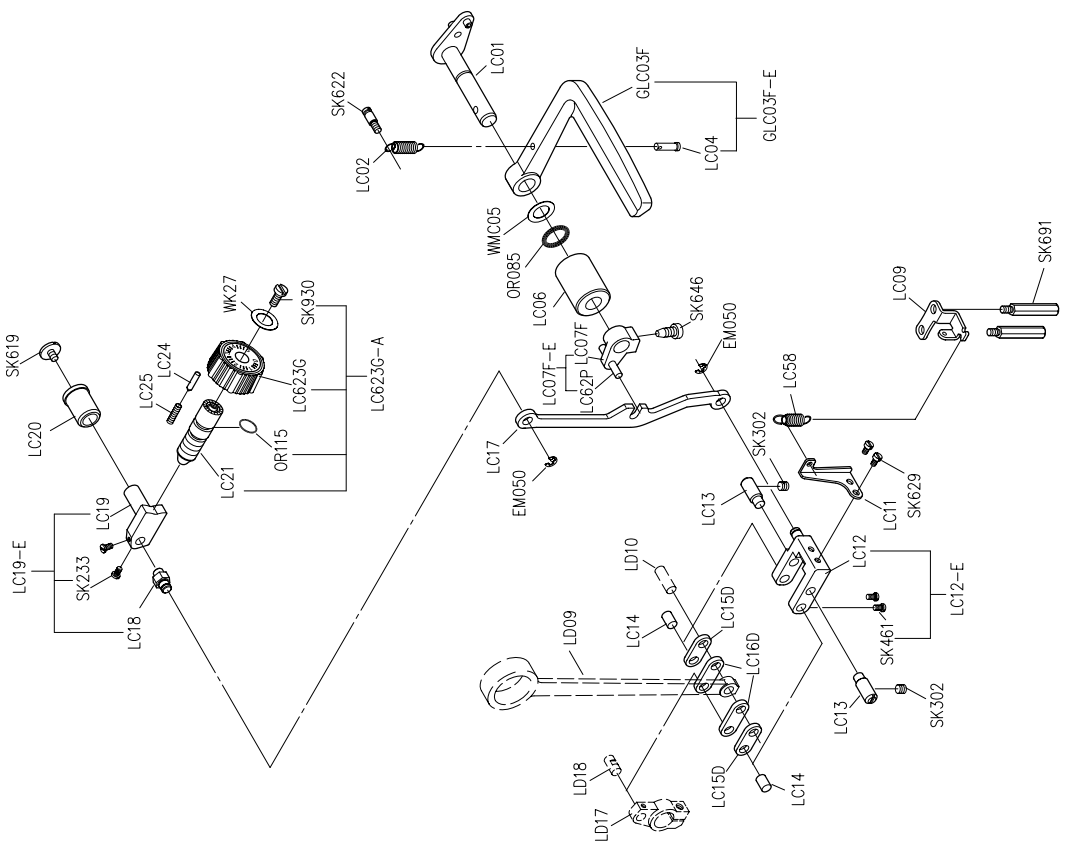

PARTS LIST FOR LC GROUP

# PARTS LIST FOR LE GROUP

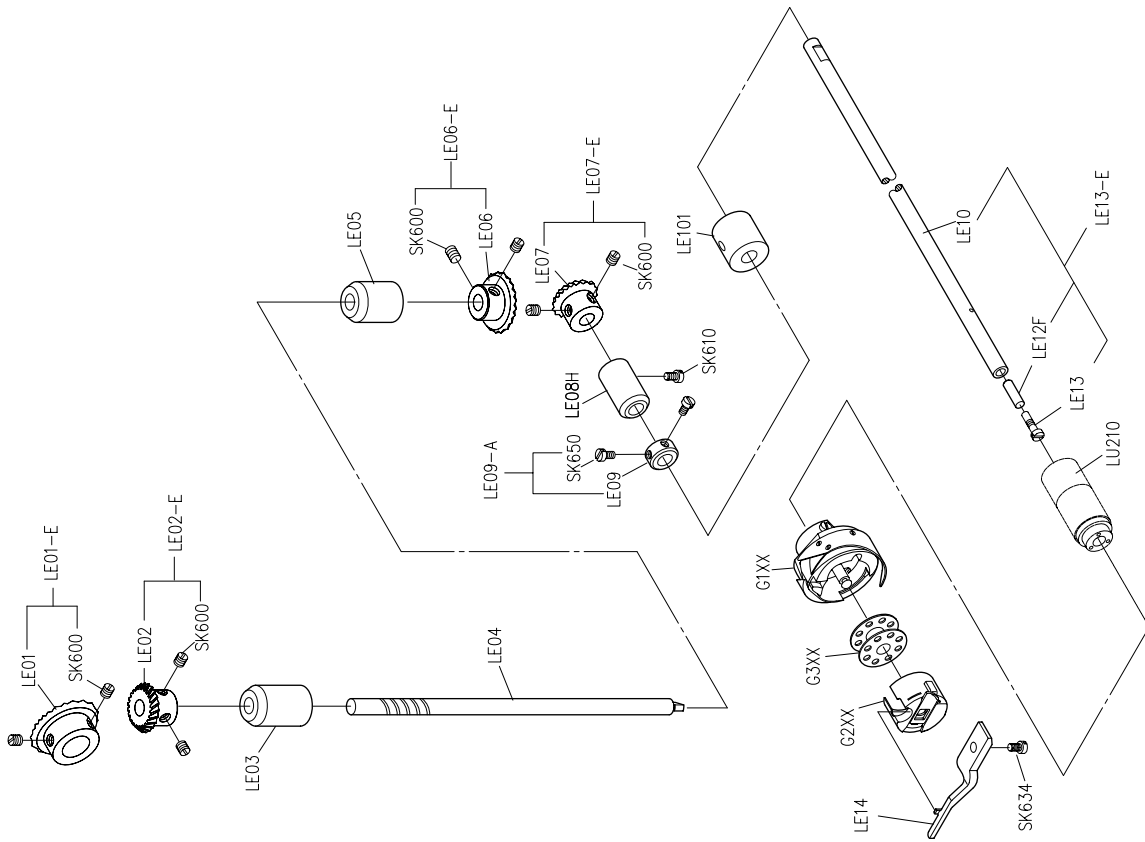

# PARTS LIST FOR LG GROUP

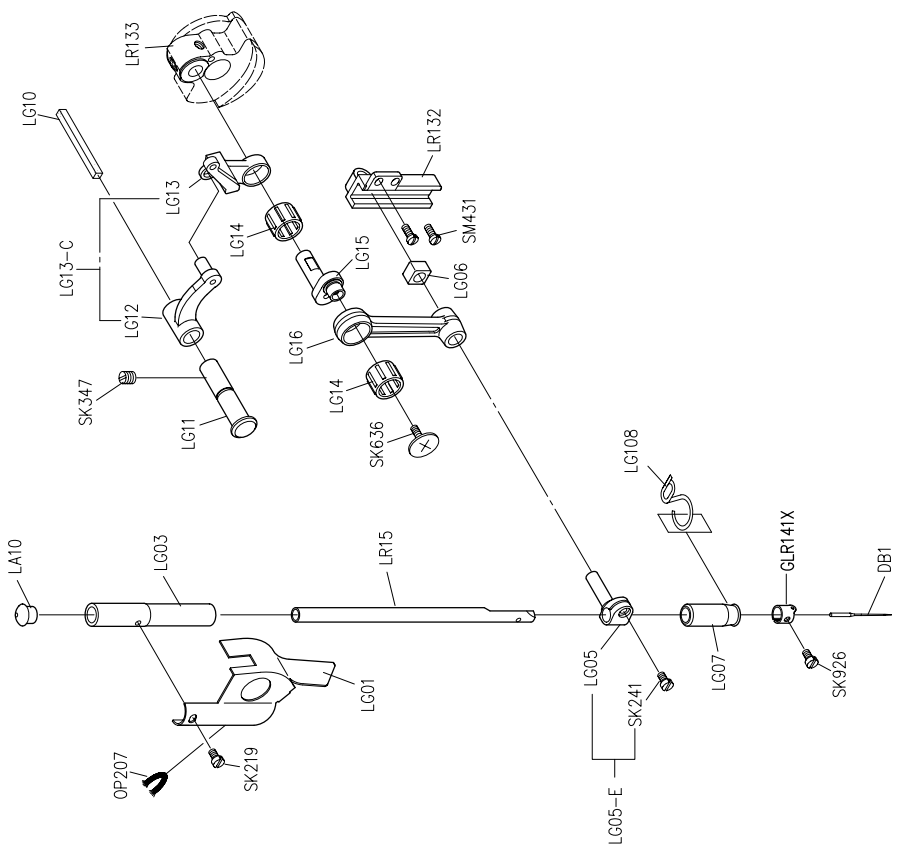

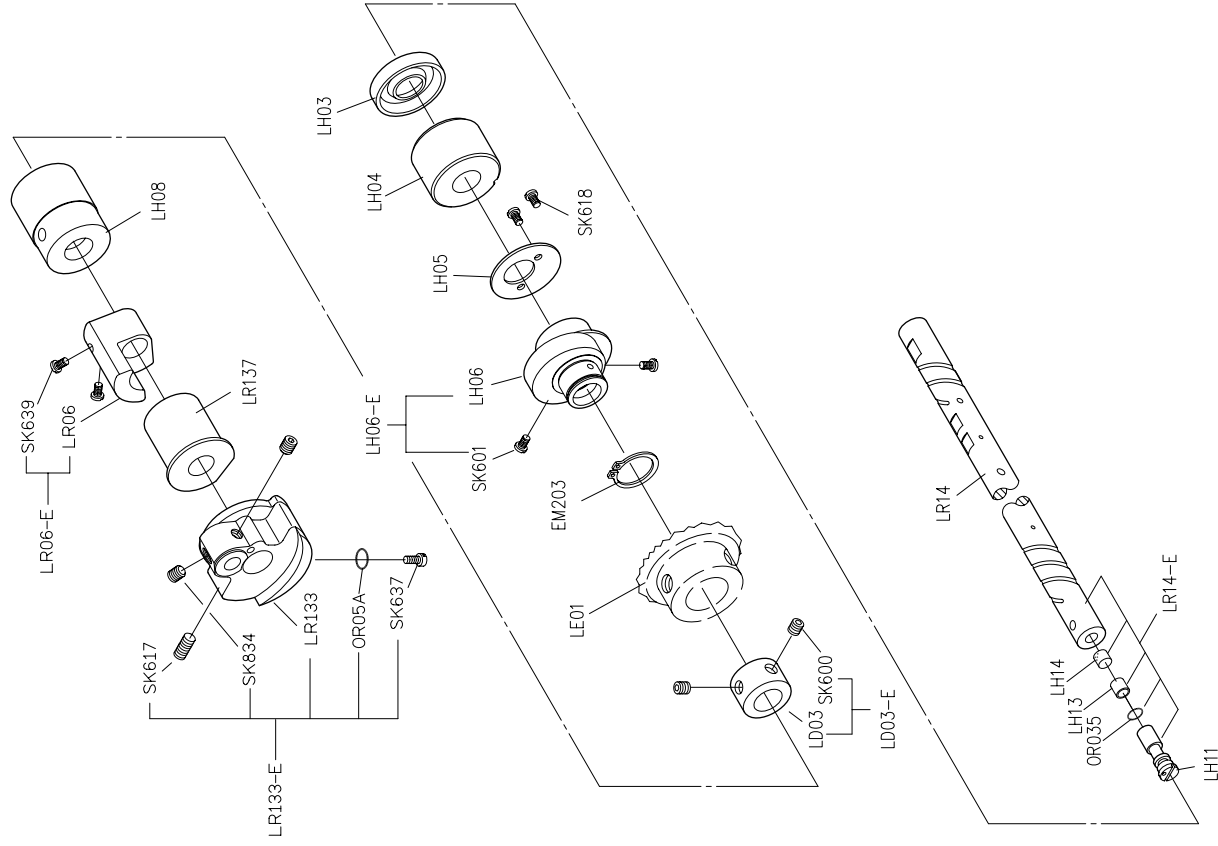

H 廠牌馬達	旋轉式切刀	旋轉式切刀
其他廠牌馬達(可加後拉輪)	GLH01-AI	GLH01-AI
P 廠牌馬達	GLH01Q-E	GLH01Q-AI
P 廠牌馬達(可加後拉輪)	GLH01P-A	GLH01Q-AI





# PARTS LIST FOR LU GROUP



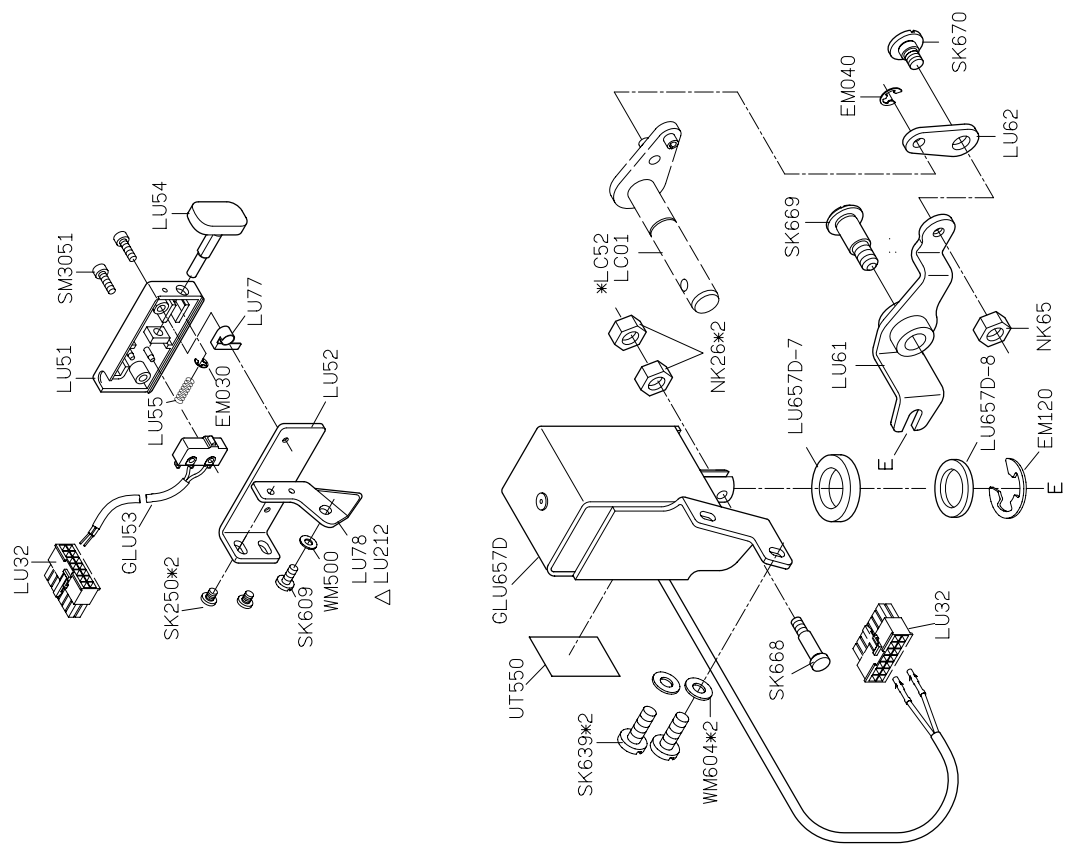
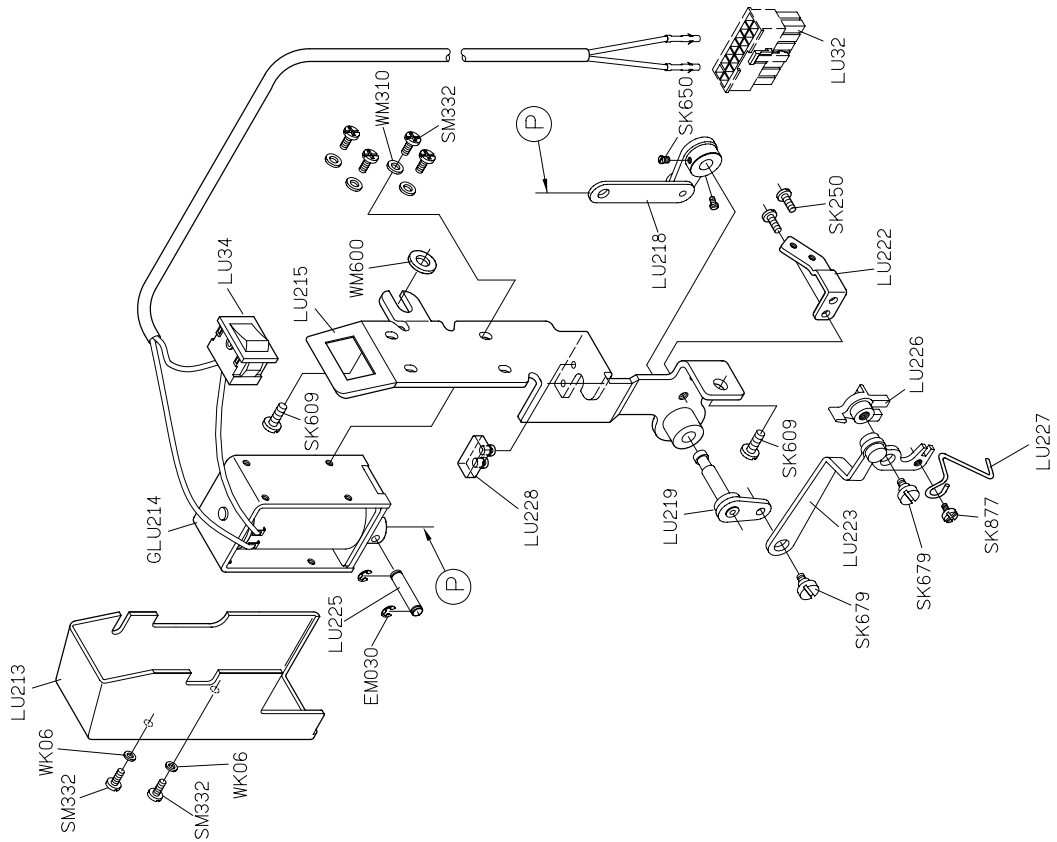







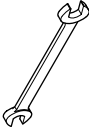

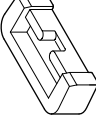
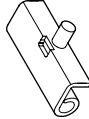

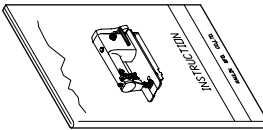
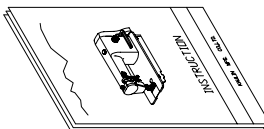
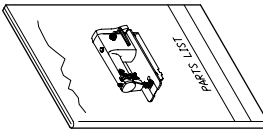
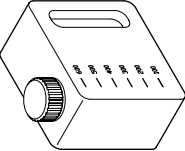
# PARTS LIST FOR LU GROUP

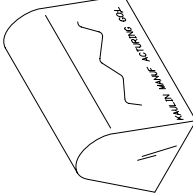

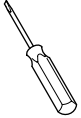

# PARTS LIST FOR LY GROUP

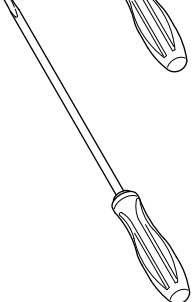
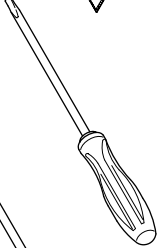
# PARTS LIST FOR LZ GROUP

L Y01		L Y02		Y M04*2		L Y05*2		Y M102*2	
L Y08F		L Y19		L Y25		L Y21-A		Y M103*2	
\$1*2		G M Y01		G3XX*2		L Y20*8		K Z03*1	
MY13		MY11		3 mm					
		K Y16		K Y17					
		G K Y26F							

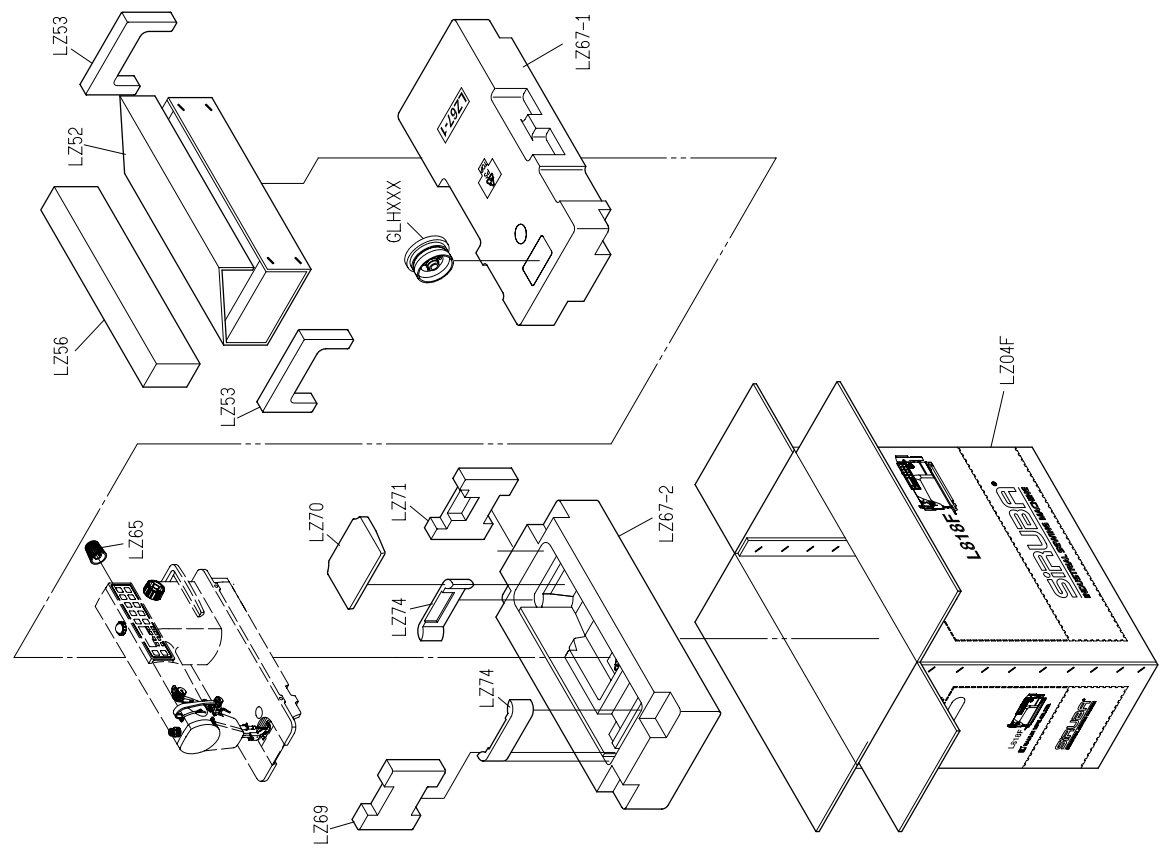

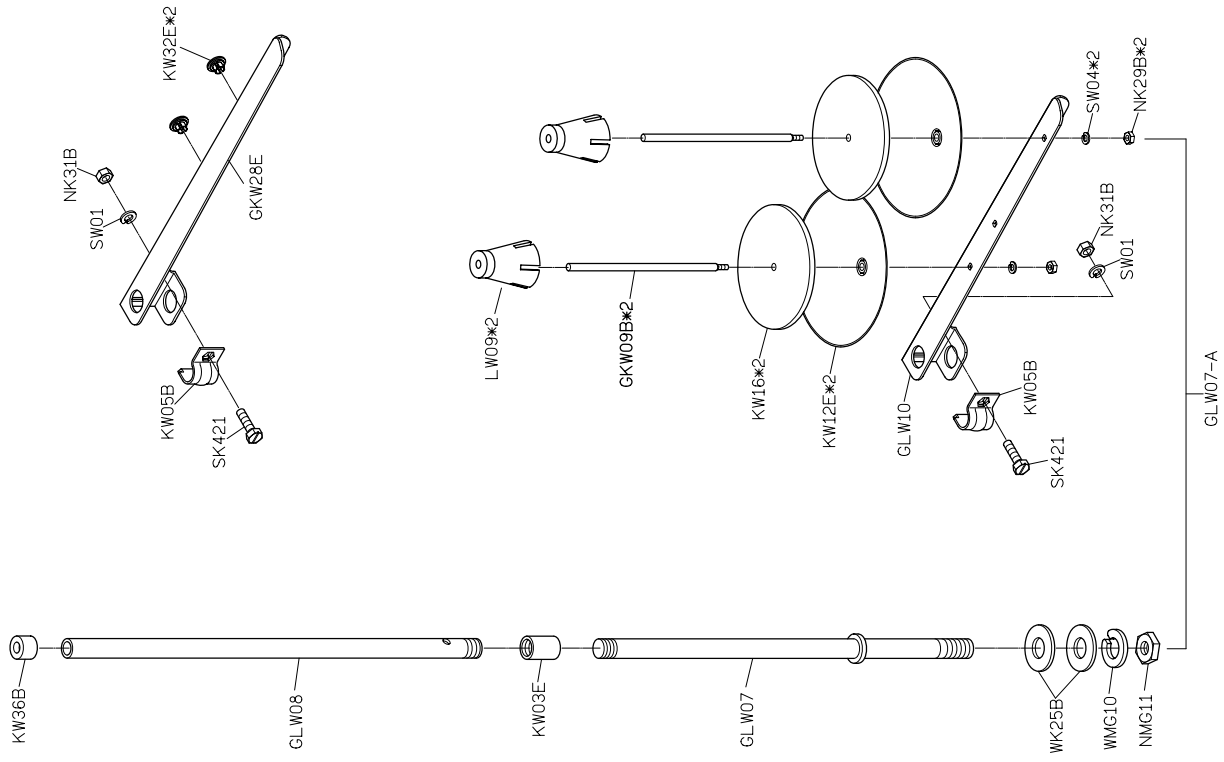

**PARTS LIST FOR THREAD STAND GROUP**



# L818F-RM1

WITH TRIMMER

高林股份有限公司 KAULIN MFG. CO., LTD.